

SPECIFICATIONS

MODEL	HBM-40M (HBM-45M) HBM-40 (HBM-45) HBM-40NC (HBM-45NC)		HBM-75 (HBM-82) HBM-75NC (HBM-82NC)	
	Metric (mm)	Imperial (inch)	Metric (mm)	Imperial (inch)
Cylinder force	40 Tons	45 Short Tons	75 Tons	82 Short Tons
Cylinder stroke length	250mm	10"	350mm	13-3/4"
Forward speed	9.6mm/sec	0.38" /sec	8.9mm/sec	0.35" /sec
Return speed	14.5mm/sec	0.57" /sec	9.9mm/sec	0.39" /sec
Fixing holes	ø83mm x 1 ø58mm x 3	ø3-1/4" x 1 ø2-9/32" x 3	ø118mm x 1 ø83mm x 3	ø4-5/8" x 1 ø3-1/4" x 3
Bending punch height	200mm	8"	300mm	12"
Bending capacity (single-V die)	200mm x 12mm	8" x 1/2"	300mm x 12mm	12" x 1/2"
NC backgauge (HBM-NC models only)	1016 mm	40"	1016 mm	40"

OPTIONAL TOOLING

Punching tool capacity	ø30mm x 9mm	ø1-1/8" x 3/8"	ø30mm x 15mm	ø1-1/8" x 5/8"
Flat plate shear (W x T)	170mm x 12mm	6-21/32" x 15/32"	170mm x 16mm	6-21/32" x 5/8"
Pipe bending range (90° bend)	ø3/8"~ø2"	ø3/8" ~ø2"	ø3/8" ~ø2"	ø3/8" ~ø2"
Straightening tool (Max profile)	200mm	8"	300mm	12"
Flat plate edge bending (W x T)	50mm x 12mm	2" x 15/32"	50mm x 12mm	2" x 15/32"
Working height	930mm	37"	950mm	37-1/2"
Electric power	5 HP	5 HP	7.5 HP	7.5 HP

HBM MODELS

Net weight (Apr.)	880 kgs	1940 lb	1880 kgs	4150 lb
Gross weight (Apr.)	990 kgs	2180 lb	2025 kgs	4460 lb
Machine dimension (Apr.)	1340x760x1185mm	53" x 30" x 47"	1780x910x1250mm	70" x 36" x 50"
Packing dimension (Apr.)	1590x980x1415mm	63" x 39" x 56"	2020x1130x1500mm	80" x 45" x 60"

HBM-NC MODELS

Net weight (Apr.)	1010 kgs	2230 lb	2010 kgs	4430 lb
Gross weight (Apr.)	1145 kgs	2520 lb	2190 kgs	4820 lb
Machine dimension (Apr.)	1340x2015x1185mm	53" x 80" x 47"	1780x2155x1250mm	70" x 85" x 50"
Packing dimension (Apr.)	1590x1330x1415mm	63" x 53" x 56"	2020x1480x1500mm	80" x 59" x 60"

• Design and specifications are subject to change without prior notice.

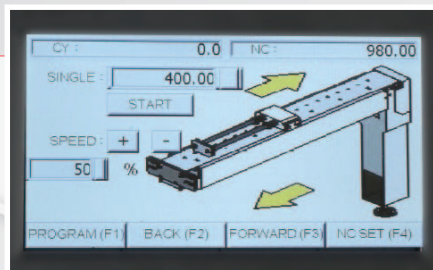

1 METER NC BACKGAUGE

- 1,016mm (40") travel distance.
- Extends accuracy and efficiency of standard bending machine.
- Operated by a color touch screen controller.
- Integrated action with the main cylinder movement, or can be turned off for manual mode.
- Immediately before bending, backgauge retracts automatically.

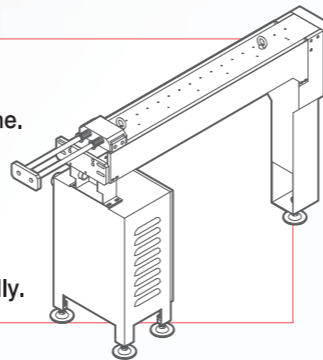

Hydraulic Horizontal Bending Machine



HBM-40NC
(with 1 meter NC backgauge)

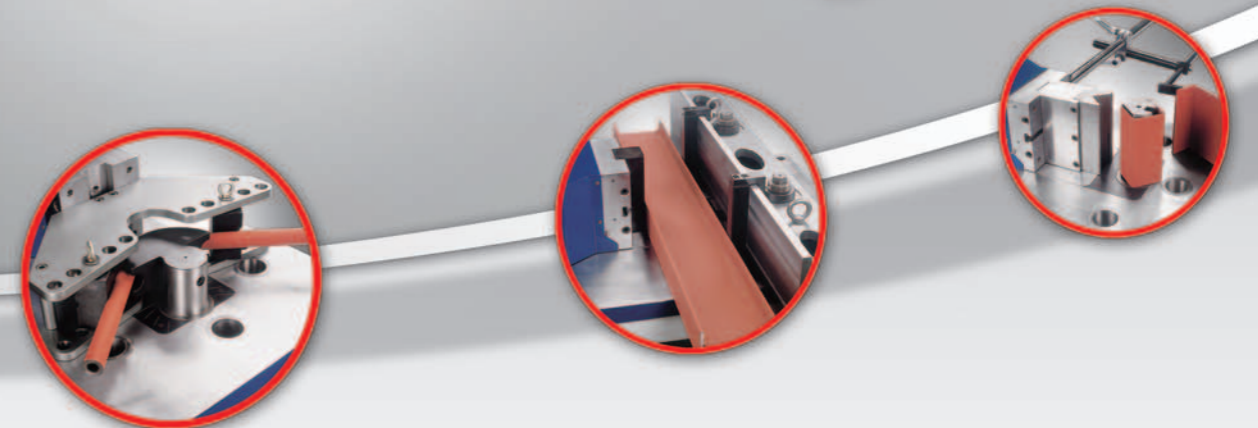

SUNRISE Fluid Power Inc.

No. 7, Road 12, Industrial Zone, Taichung City 407, Taiwan
Tel: 886-4-2359-1190 E-mail: sales@sunriseiw.com.tw
Fax: 886-4-2359-3409 Http://www.sunriseiw.com.tw



AGENT:

631EG455 2016.07

• Fast • Accurate • Durable • Versatile



Hydraulic Horizontal Bending Machine

The hydraulic horizontal bending machine is in tradition of the SUNRISE product line of high quality and reliable hydraulic metal working machines. A wide range of tooling is available for different bending operations. We also customize special tooling for specific requirements.

- Excellent repeatability of cylinder stroke at accuracy of $\pm 0.1\text{mm}$ ($\pm 0.004''$).
- Easy to learn programmable controller.
- Name-brand electric and hydraulic components ensure machine reliability.
- Manual backgauge is included for accurate positioning.



HBM-40M

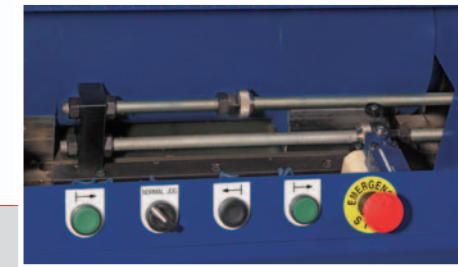

- Manual stroke adjustment with safety interlock cover. (HBM-40M model only)

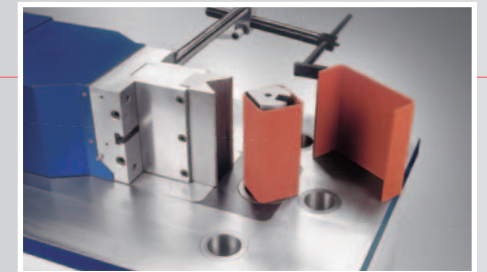

- Single-vee bending tool for thick plate.



- Multi-vee bending tool for thin plate.

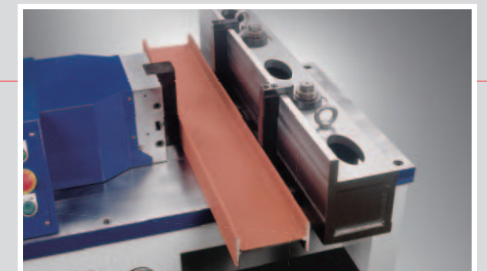

- Straightening tool for section profiles.



- Shearing tool.

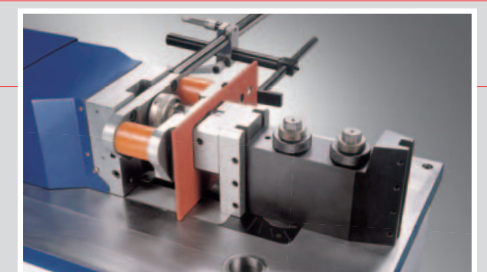

- Punching tool.



HBM-75

- HBM-NC models with CNC Backgauge for precise positioning and increased efficiency.



- 90° pipe bending tool for pipe size up to 2".



- Flat plate edge bending tool for size up to 50x12mm (WxT).

